

PRODUCT DATASHEET

LVED CV 75W/12/IP67/P G1

FULL PROGRAMMABLE OUTDOOR DRIVER



FEATURES

- Class II structure
- Input voltage: 100-240Vac~50/60Hz
- Efficiency: 87%(Typ.)
- Plastic housing structure, protection grade: IP67
- Lightning protection level: differential mode 4KV
- All-round protection: output temperature, output over-voltage, output over-current, short circuit protection
- 3 years warranty

PRODUCT INTRODUCTION

75W is a series of constant voltage products with output power of 75W. Can operate in the input voltage range of 90-264Vac, and provide 12Vdc,24Vdc,36Vdc,48Vdc, with perfect output over temperature, over voltage, over current, overload, short circuit protection. The product is designed with IP67 protection grade. The plastic housing greatly improves the reliability of outdoor applications. Provide reliable power supply solutions for outdoor landscape lighting, architectural lighting, and advertising signage lighting.

TECHNICAL DATA

Model List

Model	Input Voltage	Output Power	Output Voltage	The Default Current	Eff. (Typ.)	PF
75W-V12	100-240V 50/60Hz	75W	12Vdc	0-6.25A	≥85%	0.5
75W-V24	100-240V 50/60Hz	75W	24Vdc	0-3.13A	≥87%	0.5

Note
 1. Test conditions of the above parameters: Ta=25°C, 230Vac input, full load operation for 30 minutes;
 2. Including setting error, linear adjustment rate and load adjustment rate;
 3. Power supply is used as a component with terminal equipment. EMC is affected by the whole set of devices. Terminal equipment manufacturers need to re-confirm the EMC for the whole set of devices.

Input Characteristics

Parameter	Min	Typ.	Max	Note
Rated input voltage	100Vac 140Vdc	230Vac	240Vac 330Vdc	-
Input Voltage Range	90Vac	-	264Vac	-
Rated frequency	47Hz	50/60Hz	63Hz	-
Power factor	-	>0.5	-	Full load, 230Vac input
Input current	-	-	1.4A	Full load, 100Vac input
Inrush current	-	-	70A	230Vac, Cold start (25°C)
16A Circuit breaker The number of power supplies of the same model can be configured	6pcs (Type B circuit breaker) 11pcs (Type C circuit breaker) for 230Vac input			

Output Characteristics

Parameter	Min	Typ.	Max	Note
Rated current 75W-V12 75W-V24	-	6.25A 3.13A	-	-
Output current range 75W-V12 75W-V24	0	-	6.25A 3.13A	-
Rated output voltage 75W-V12 75W-V24	-	12V 24V	-	-
Rated power (100-240Vac)	-	75W	-	-

Parameter	Min	Typ.	Max	Note
No-load voltage 75W-V12 75W-V24	-	-	12.5V 24.5V	-
Efficiency@230Vac 75W-V12 75W-V24	85% 87%	87% 87%	-	Full load @230Vac
Output voltage Ripple	-	<2%	-	Full load
Accuracy of output voltage	-3%	-	+3%	Full load
Line regulation	-2%	-	+2%	50-100% load@230Vac
Load regulation	-2%	-	+2%	50-100% load@230Vac
Starting time	-	-	500ms	Full load@230Vac

Input Characteristics

Function	Function instructions
Output overload protection	Protection mode: hiccup mode, recovers automatically after fault condition is removed.
Output short circuit protection	Hiccup mode: recovers automatically after fault condition is removed
Output over-voltage protection	Output voltage > working voltage 1.08-1.2 Hiccup mode: recovers automatically after fault condition is removed
Output over-current protection	Output current >1.1-1.5 times, Hiccup mode: recovers automatically after fault condition is removed

Safety and EMC

Safety categories	Standard
Safety	GB4943.1, IEC62368-1, EN62368-1, UL8750
EMC	GB/T 9254.1, EN55032/55035
Surge protection	Differential mode L-N ±2KV (2 ohm), Refer to IEC61000-4-5 2014
High-pot test	I/P-O/P:3.75KVac
Insulation impedance	I/P-O/P:100M Ohms/500Vdc/ 25°C/ 70% RH
Leakage current	<5mA@240Vac

Environmental

Environmental categories	Parameter
Working temperature	-40~55°C/90°C@230Vac;-40~45°C/90°C@100Vac(refer to "Life Curve")
Safe housing temperature	-40~90°C
Working humidity	20 ~ 95% RH, non condensing
Storage temperature / humidity	-40 ~ +80°C, 10 ~ 90% RH
Resistant to vibration	10 ~ 500Hz, 5G 12 min/cycle, X, Y, Z axis 72 min each
MTBF	230Khrs min. MIL-HDBK-217F (Ta=25°C)
Lifetime	30,000 hours @Tc<75°C, 230Vac, 100% Load, Please refer to "Tcase VS Lifetime" section

Inrush Current

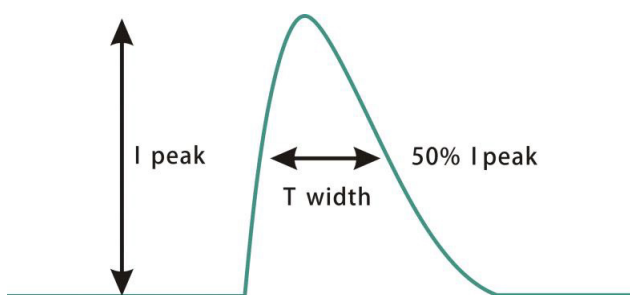

Input Voltage	Peak Current	T(@50% Peak current)
100Vac	28A	261us
230Vac	67A	233us
264Vac	72A	245us

Note: After triggering OTP, there is a flashing light phenomenon on the input switch

Dimensions & Weight

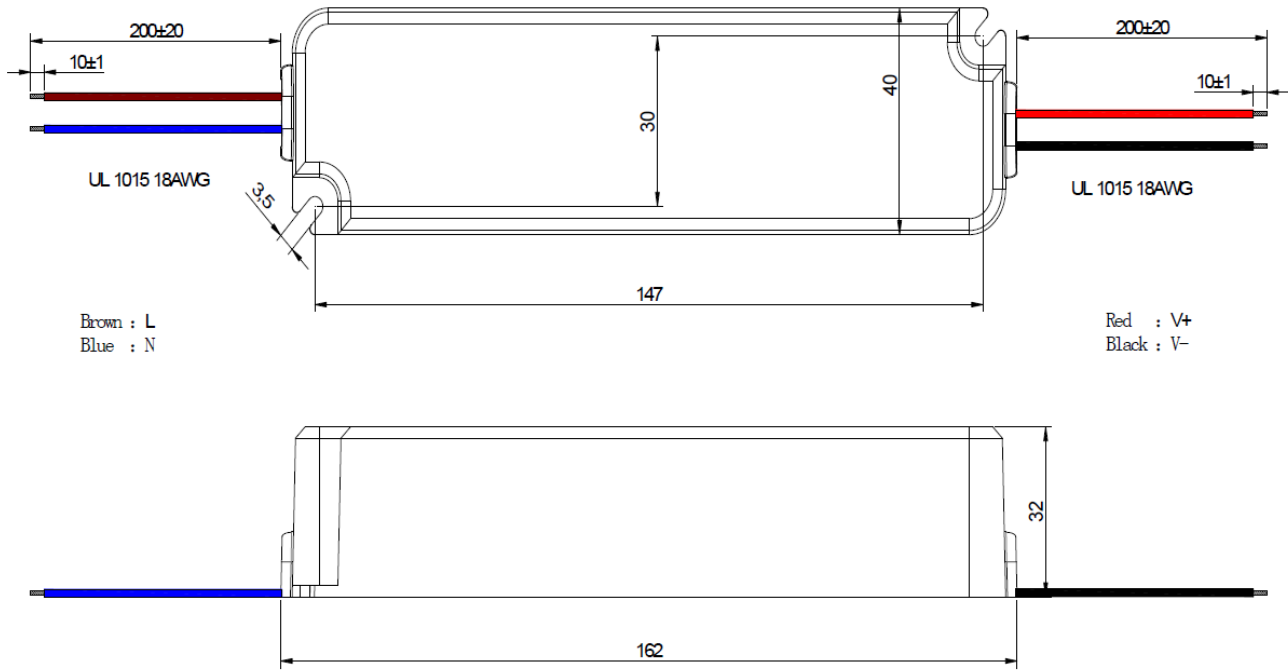

Length	162 mm	Weight	350 / g
Width	40 mm	Diameter	/ mm
Height	32 mm	Other requirements	/
Cable Size	200±20mm		
Packaging	L475 * W350 * H160 / One Carton 3 layers and 16pcs each layer, total 64pcs/carton.		

Curve

Eff. VS Output current

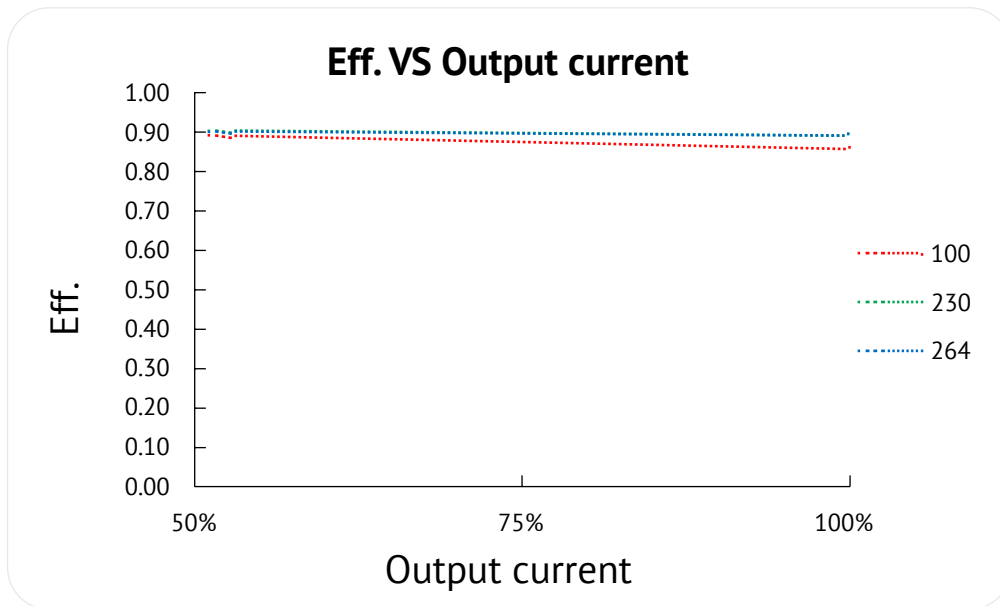

Lifetime VS Tcase

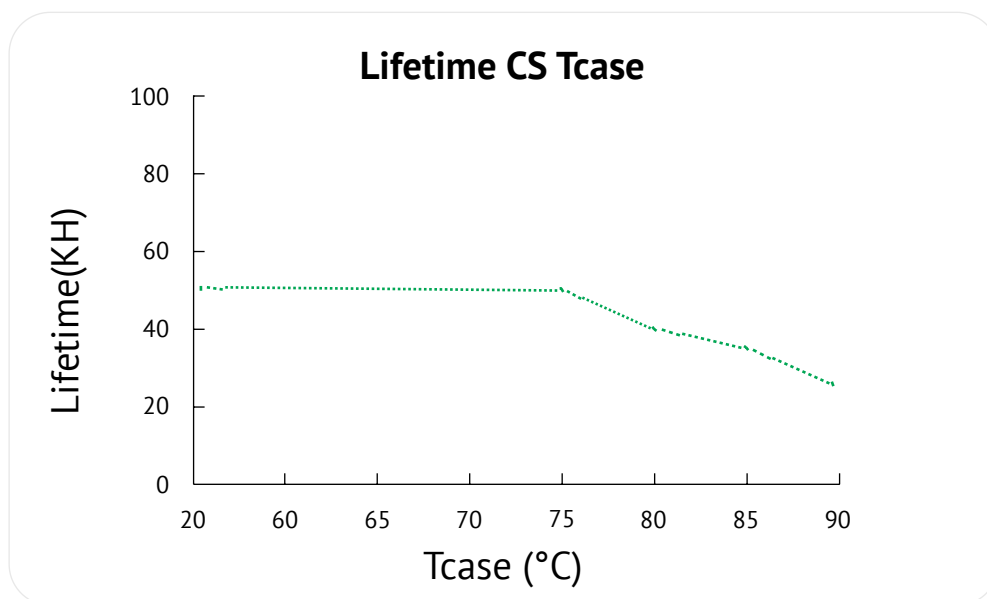

Curve

Output power VS Tcase

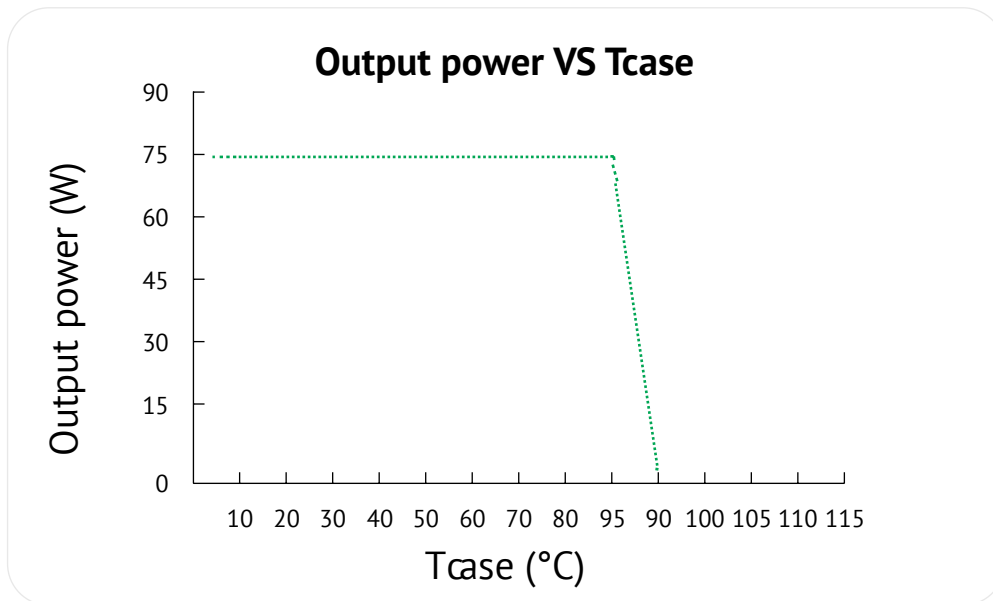

Output power VS Input voltage

